

Operating and Installation Instructions

CAUTION!

This product is to be installed only by persons knowledgeable in the repair and modification of vehicle fuel systems and general vehicle systems modification. Only a qualified technician or mechanic who is aware of applicable safety procedures and fabrication skills should perform the installation of this product.

This fuel pump utilizes an electronic DC motor system that is not typical of conventional fuel pumps, and therefore extra precautions must be adhered to as contained in instructions herein

GASOLINE AND OTHER FUELS ARE FLAMMABLE AND CAN BE EXPLOSIVE!

Perform the installation in a well ventilated location only to minimize the build up of fuel vapors. **NO** open flames, smoking or other sources of ignition are to be present during installation, to prevent fire or explosion that can cause serious injury or death. Grinding, cutting, and drilling must be performed with care to prevent ignition. Draining and removal of all fuel and ventilation of vapors in vehicle and fuel system is recommended when performing such procedures. Proper eye and personal protection is required at all times during installation.

WARNING!

The Vehicle's fuel system may be under pressure! Do not loosen any fuel connections until relieving all fuel system pressure. Consult an applicable service manual for instructions to relieve fuel system pressure safely.

This product is intended for racing, off-road, or marine use only. This fuel system component may not be legal for sale or use on emission controlled motor vehicles; consult local, state and national laws.

Product Contents:

Check the diagram and list of components (right) to ensure that no components are missing from box. Contact your Fuelab distributor immediately for replacement.

47401 Features and Performance Ratings:

Inlet and Outlet Port Sizes	-8AN Military Port
Rated Flow Rate	66 GPH @ 45 PSI, 13.5V (250 LPH @ 3 Bar)
Maximum Pressure	125 PSI (8.5 Bar)
Operating Voltage	8-17 Volts

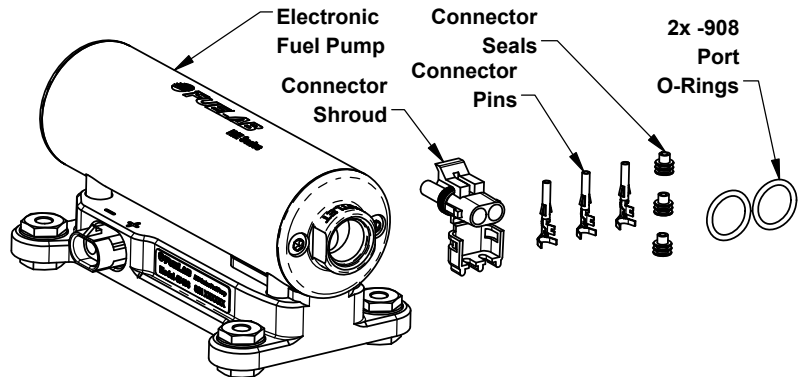

WARNING! Power Supply Voltage must be constant as specified in above specification. Only install fuel pump on vehicles using 12 Volt (6 cell lead acid battery) with a normal operating alternator charging system or vehicles using 16 Volt (8 cell lead acid battery) with no charging system. Pulse-Width Modulation or other means of reducing input power voltage may result in erratic or non-operational condition. Electronic Power Supplies have not shown to be a problem with normal operation, however testing has not been performed on all systems.

Before Installation, Plan Entire Fuel System:

A complete design plan of entire fuel system must be created for the specific application. These instructions are a guide to help design this plan with respects to integrating this model of fuel pump only. Consult other sources of information and manufacturers instructions for the various components of the fuel system. These instructions are limited to general topics of fuel pump installation and may not include specific information pertaining to your specific application. These instructions are written assuming the use of Multi-Point Electronic Fuel Injection using a standard return (bypass) style fuel pressure regulator. This fuel pump may be integrated in some general carbureted systems using a bypass system. Visit our company website (www.fuelab.com) for specific details pertaining to example fuel systems and other solution ideas. Additional information including advanced troubleshooting, any special alerts and FAQ's pertaining to this and other products is also available. A good design plan for the fuel system must contain consideration for: Pressure and flow rate through various components, quality of components, operating environment (temperature, vibration, shock, general exposure to elements) and local area laws. Begin installation of fuel pump only after a complete plan is established to help avoid fuel system component failure, costly rework, and excessive installation time.

Plumbing Planning Notes:

This fuel pump is for external mounting only! Submersion in fuel or other liquids can cause damage to fuel pump. Other in-tank solutions are available from Fuelab. Adequate structural mounting and support is the responsibility of the fabricator / installer. Mount the fuel pump as low as possible without it being vulnerable to road hazards or debris. Minimize the length of the fuel line feeding fuel pump. Do not use "cross drilled" style 90° elbow fittings, check valves or other restrictions (other than high flow fuel filter or shut-off valve) before fuel pump. Minimize plumbing restrictions between fuel tank and fuel pump and regulator for peak performance, use -8AN (1/2") to -12AN (3/4") line for feeding the fuel pump. Typically -6AN (3/8") to -8AN (1/2") line is required for the rest of the fuel system. Note regulator manufacturer's line size recommendations for the rest of the fuel system. Use of a strainer filter upstream of fuel pump is required to protect fuel pump from damage. All fuel line used must handle high pressure. The use of fuel line such as stainless steel braided line and "AN" style fitting connections is recommended. The fuel ports (one -8AN Inlet Port and one -8AN Outlet Port) use "AN" or "military" style fittings. This plumbing standard is commonly used with racing and high performance applications. Use of Expander Fitting per Fuelab Model 72302 (-8AN to -10AN) is recommended for adapting line size. See step 4 on page 5, for additional information on this port standard. A fuel filter with a 60 micron or finer particle rating is required to be used upstream of regulator and downstream from fuel pump to protect it and the fuel injectors from foreign object damage. Reference the Schematic Diagram below for filter locations. Fuel tank must have a modification of an additional sump, or use aftermarket fuel cell as indicated. Use of a "pick-up" tube system for feeding fuel to pump is not recommended. If a "pick-up" tube system is employed, use **ONLY** -10AN (5/8") sized line or larger! Use of a liquid filled gauge exposed to engine compartment heat is not recommended as the liquid inside the gauge may exert measurement errors. **DO NOT** plumb to any gauge mounted inside the vehicle or in passenger compartment. A line burst can spill fuel inside passenger compartment and on occupants, possibly causing serious injury or death. An electric gauge or pressure transducer system is recommended for readings in a passenger compartment.

Typical EFI V-8 Fuel System Plumbing Schematic Diagram:

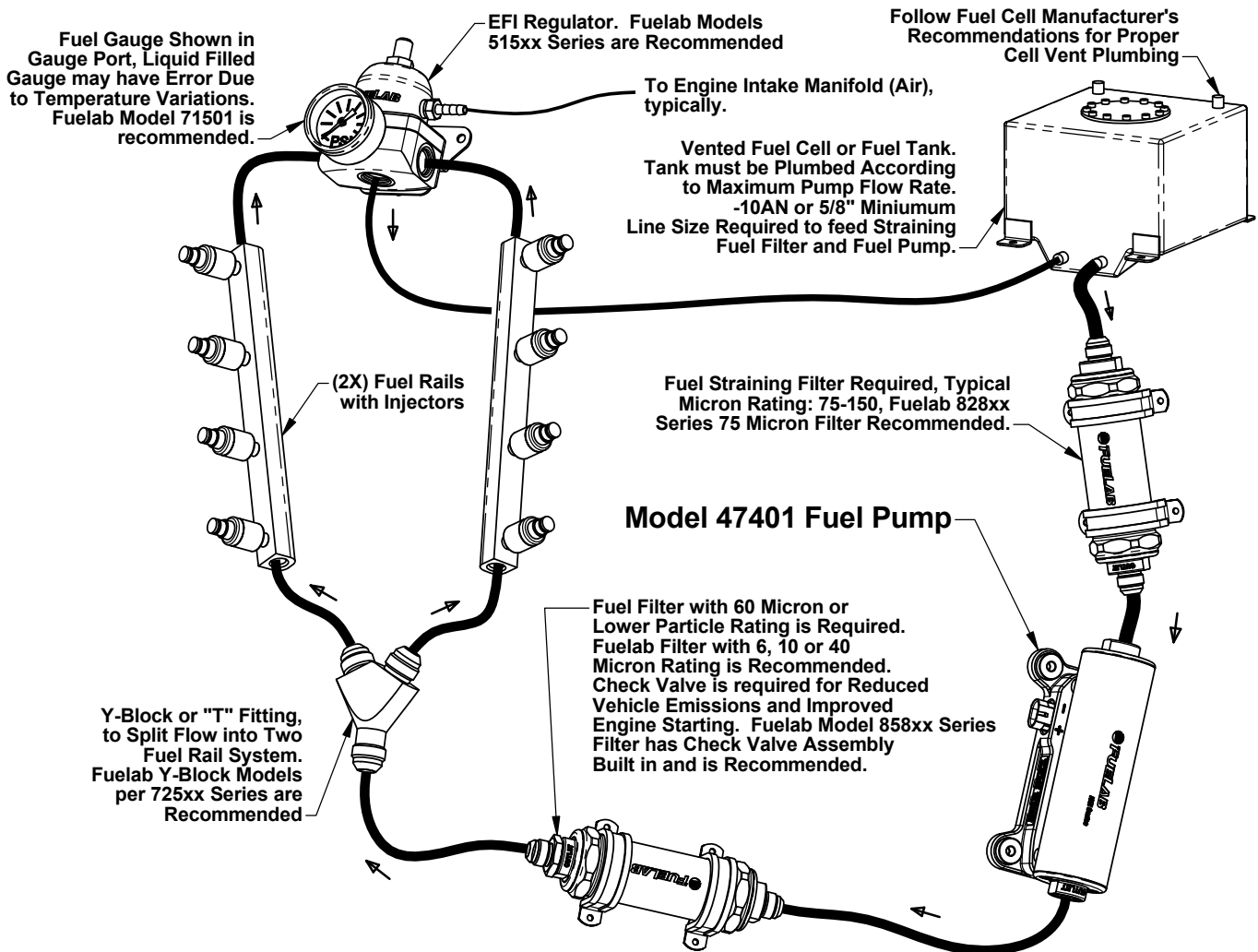

Special Note: Use in carbureted systems require a bypass return or relief valve.
Do not "Dead Head" Fuel Pump.

Electrical Planning Notes:

Reference below, for schematic wiring diagram example. Use electrical components as described, including electrical connectors that are appropriate for the operating environment of the fuel system, whether its use in street, racing, or marine applications. Pump's Electrical Connector is compatible with Delphi Weather Pack®; two pin female connectors (such as P/N 12015792), that is included. All electrical connectors for the power leads must be capable of high current draw, note all connections, wire and component rating requirements herein. Solder can be used if crimp connections are not reliable, and use shrink wrap for wire splices for extra reliability. Use of a check valve in fuel system as shown in plumbing diagram will maintain fuel pressure at normal levels during engine starting and may be required depending on the wiring of main relay control circuit. OEM and some aftermarket ECMs have fuel pump relay control outputs can be used that will turn off fuel pump during engine starting, requiring check valve use. If the fuel pressure does not maintain during engine starting, ensure fuel pump is energized while starting. Main wiring schematic diagram, below shows the control of relay by ignition switch. This source can be changed as described, or by a toggle switch. Some forms of racing have specific rules regarding electrical switching of fuel pump, including protective measures such as oil pressure switches that turn off pump in case engine stops running, as a safety feature. Consult appropriate racing guidelines, rules and regulations.

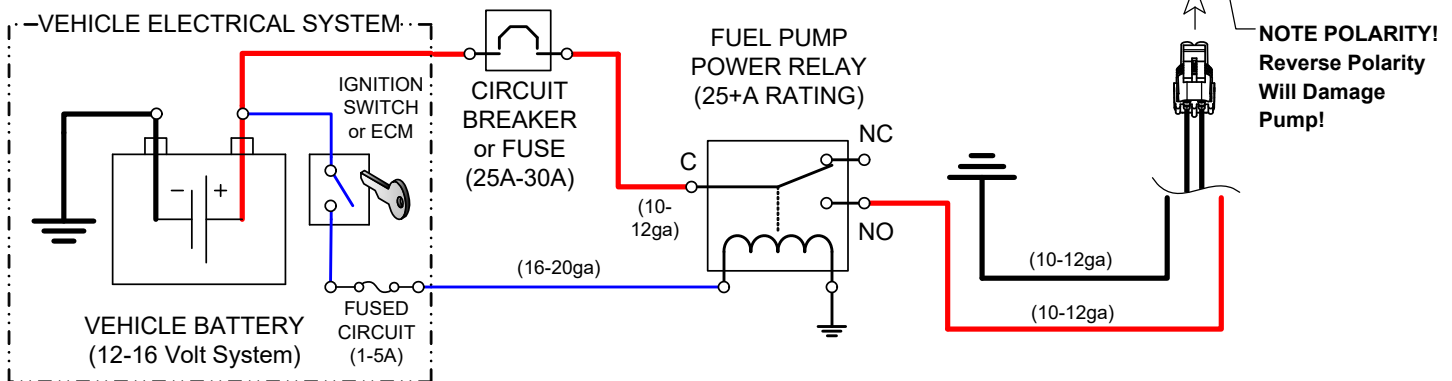

Installation Steps:

1. Disconnect the ground terminal from battery and allow the vehicle's engine and exhaust system to cool. Relieve fuel system pressure per applicable service manual. Follow all Warnings, Cautions and Instructions written on previous pages of these instructions.
2. Modify, remove or replace other fuel system components as required per established build plan (reference notes on previous pages and above).
3. Choose a location for the fuel pump that minimizes exposure to road hazards and debris, away from engine exhaust pipes, near fuel tank or cell (keep pump as low as possible to help "draw" fuel in). Note position and plumbing requirements as stated earlier in these instructions. All plumbing must be in accordance to instructions herein, particularly with all upstream plumbing (between fuel tank and fuel pump)! Excessive restrictions upstream of the fuel pump will permanently damage the fuel pump. Fuel pump has an incorporated mounting bracket with shock dampeners. Use the pump as a template to aid in determining location for mounting hardware (1/4" hardened fasteners are recommended).
4. Install the fuel fittings (not supplied). The threads used on these *Fuel Ports* are not tapered or pipe threads. Do not use Teflon® thread tape or thread sealant on these threads, as this can cause leakage or introduce debris into the fuel system. Fittings to be used with these style of ports require use of the enclosed -910 *O-rings* for proper sealing. Use light oil to lubricate the *O-rings* just prior to installation. Install the *O-rings* onto the fuel fitting first. Position the *O-ring* in the thread relief of the fitting. Thread fitting into fuel pump and tighten between 5 and 15 ft·lbs of torque.
5. Inspect fuel system for any contact of fuel lines or wires with other components that can cause chafing or rubbing. Secure all components and fuel lines. Ensure that moving components of vehicle are clear.
6. Connect the vehicle's battery. Perform initial priming: The Fuel Pump may require priming during initial operation and for moment after depletion of fuel from fuel tank or cell. This action can be accomplished by removing fuel line from fuel rail (downstream of fuel pump and filters), allowing the fuel line to empty fluid into fuel safe container. Operate fuel pump until fuel exits fuel line. Attach fuel line back to the fuel rail after priming fuel pump. After tightening connection, verify leak-free operation while checking fuel rail pressure. If fuel pressure is not high enough, repeat priming procedure to ensure that fuel pump is receiving fuel from tank. Turn on fuel pump (typically by bypassing fuel pump relay) without engine operating. ECU or engine management computer may be controlling the relay. The ECU may only operate pump for a few seconds each time ignition switch is set to on. The pump will have to operate several seconds (30+) to prime and drive air out

of the fuel system. Reattach fuel rail line. Start fuel system and inspect for leaks. Inspect vehicle for any leaks. Turn off fuel system and repair any leaks that may be present before continuing.

7. When adjusting pressure, be sure that fuel pump is operating to monitor pressure. Fuelab recommends to use a "baseline" pressure reference when adjusting the pressure (adjusting the pressure with engine off or *Pressure Reference Line* unhooked). The vehicle's engine may not produce consistent vacuum during idle to have repeatable readings.
8. After final adjustment of fuel pressure, tighten *Jam Nut*. Road test vehicle, and retest pressure upon return to ensure accurate adjustment. After installation of this fuel pump, verify flow capacity to ensure safe levels of flow, particularly with reduced levels of pump speed. Having insufficient flow capacity can result in an engine lean-out condition that can cause severe engine damage. Collecting a given amount of fuel (as measured by weight or volume) over a measured amount of time can be used to determine capacity. Collect fuel flow from the return line to measure the amount of fuel capacity at a given operating pressure. A 20+ ampere capacity battery charger may be used to simulate the charging system of the vehicle while engine is off. If using an adjustable fuel pressure regulator, for boosted applications, simulate boost by raising the fuel pressure by the amount of expected maximum boost pressure. Performing these tests will give greater accuracy for capacity tests.

Fuel System Maintenance Notes:

Periodic inspection and general maintenance is required for longevity and reliability of the fuel system. This action directly affects the fuel pump's performance and reliability. Included with that are periodic inspection and/or filter element replacement. Straining Filters (upstream of pump) should be checked and cleaned at least every 15,000 miles (more often for off-road operating conditions). Replace or clean downstream filters (after pump) every year or 15,000 miles (more often for off-road operating conditions). Dirty fuel filters can block flow and adversely effect fuel system performance as well as can directly damage the fuel pump.

Special alert for E85 or Methanol Users: **DO NOT** use cellulose (paper) based filter elements! Water can contaminate the fuel and break down the element, creating debris that can damage injectors and fuel pump. E85, Methanol and other oxygenated fuels can absorb water. Long term storage of this fuel within the fuel tank of vehicle is not recommended and can contribute to rusting of the fuel pump's tool steel components. Draining the fuel tank and replacement with small amount of Gasoline or Kerosene (along with operating the fuel system for a small period of time) is recommended for long term storage of the vehicle.

Troubleshooting Notes:

Problem (Symptom)	Possible Causes	Possible Solutions
Not operating or slight "clicking" sound when turned on.	<ul style="list-style-type: none"> • Faulty fuel pump relay. • Faulty, dirty or corroded terminals or improperly sized wire. • Debris from tank or plumbing lodged inside pump. 	Check voltage to Fuel Pump, at power terminals. If voltage is steady and consistent (within 1/2 Volt of battery) then contact Fuelab for assistance or repair. If voltage is inconsistent as described, repair or replace electrical components as required.
Not building up fuel pressure.	<ul style="list-style-type: none"> • Incorrect fuel system initial priming procedure. • Loose inlet fuel fittings or leaking plumbing on inlet side (letting in air). 	Repeat procedure for proper priming. If condition continues, check all plumbing upstream (on inlet side) of fuel pump.
Leakage of fuel at inlet or outlet fuel ports.	<ul style="list-style-type: none"> • Improper type of fitting used. 	If leakage is occurring between the end caps and sleeve or controller base of pump, contact Fuelab immediately for repair or replacement. If leakage occurs at fitting, be sure that the proper fitting style is used (AN o-ring seal type ONLY!). Pipe Threaded style fittings are NOT to be used. If proper style of fittings are being used, be sure that o-ring is being used on fitting or replace o-ring.

Problem (Symptom)	Possible Causes	Possible Solutions
Loss of fuel pressure or erratic pressure pulsation after several minutes of operation.	<ul style="list-style-type: none"> • Cavitation (vapor lock) due to overheating or restricted inlet. 	Check temperature of pump right after failure. If pump is hot to touch (cannot leave hand on pump due to it being too hot, or above 120°F), then look for sources of heat such as exhaust or fuel rail mountings that could be conducting too much heat. If pump is not hot to the touch, check for inlet restrictions such as improperly vented tank, kinks in the fuel line, or too small of plumbing for application. Contact Fuelab, as pump may be damaged due to improper operating condition for repair or consultation.

Please do not return this product to your retailer. If you experience any performance, reliability or problems during installation or use of this product, please contact Fuelab immediately!

For more tips, advise or troubleshooting please visit our website at www.fuelab.com, e-mail message to info@fuelab.com or call our tech department at 800-541-2345 or 618-344-3300 between 8am and 5pm Central Standard Time.



www.fuelab.com
 1605 Eastport Plaza Drive, Suite 125, Collinsville, IL 62234
 800-541-2345

LIMITED WARRANTY

FUELAB, a division of FCP, Inc., having its principal place of business at **1605 Eastport Plaza Drive, Suite 125, Collinsville, IL 62234, USA** ("Manufacturer") warrants its **FUELAB** products (the "Products") as follows:

1. Limited Warranty.

Manufacturer warrants that the Products sold hereunder will be free from defects in material and workmanship for a period of 2 Years from the date of purchase to the original purchaser. If the Products do not conform to this Limited Warranty during the warranty period (as herein above specified), Buyer shall notify Manufacturer in writing, or by phone, of the claimed defects and demonstrate to Manufacturer satisfaction that said defects are covered by this Limited Warranty. If the defects are properly reported to Manufacturer within the warranty period, and the defects are of such type and nature as to be covered by this warranty, Manufacturer shall, at its own expense, furnish replacement Products or, at Manufacturer's option, replacement parts for the defective Products. Removal of Products from vehicle (*Vehicle means any automotive, bike or marine transportation powered by an internal combustion engine. This product is **NOT** intended or designed for use on aircraft, experimental or otherwise.*), shipping to Manufacturer and installation of the replacement Products or replacement parts shall be at Buyer's expense.

2. Other Limits.

THE FOREGOING IS IN LIEU OF ALL OTHER WARRANTIES, EXPRESS OR IMPLIED, INCLUDING BUT NOT LIMITED TO THE IMPLIED WARRANTIES OF MERCHANTABILITY AND FITNESS FOR A PARTICULAR PURPOSE. Manufacturer does not warrant against damages or defects arising out of improper or abnormal use or handling of the Products; against defects or damages arising from improper installation (where installation is by persons other than Manufacturer), against defects in products or components not manufactured by Manufacturer, or against damages resulting from such non-Manufacturer made products or components. Manufacturer passes on to Buyer the warranty it received (if any) from the maker thereof of such non-Manufacturer made products or components. This warranty also does not apply to Products upon which repairs have been effected or attempted by persons other than pursuant to written authorization by Manufacturer.

3. Exclusive Obligation.

THIS WARRANTY IS EXCLUSIVE. The sole and exclusive obligation of Manufacturer shall be to repair or replace the defective Products in the manner and for the period provided above. Manufacturer shall not have any other obligation with respect to the Products or any part thereof, whether based on contract, tort, strict liability or otherwise. Under no circumstances, whether based on this Limited Warranty or otherwise, shall Manufacturer be liable for incidental, special, or consequential damages.

4. Other Statements.

Manufacturer's employees, representatives' and/or resellers ORAL OR OTHER WRITTEN STATEMENTS DO NOT CONSTITUTE WARRANTIES, shall not be relied upon by Buyer, and are not a part of the contract for sale or this limited warranty.

5. Entire Obligation.

This Limited Warranty states the entire obligation of Manufacturer with respect to the Products. If any part of this Limited Warranty is determined to be void or illegal, the remainder shall remain in full force and effect.

6. Warranty Service

What Does This Warranty Not Cover? Any problem that is caused by abuse, misuse, or an act of God (such as a flood) is not covered. Also, consequential and incidental damages are not recoverable under this warranty. Some states do not allow the exclusion or limitation of incidental or consequential damages, so the above limitation or exclusion may not apply to you.

How Do You Get Service? In order to be eligible for service under this warranty you **MUST** return the Warranty Registration card, or register on-line at www.fuelab.com/warranty-registration within 30 days of purchasing the Product.

If something goes wrong with your product contact FUELAB at 618-344-3300, or send an e-mail to: info@fuelab.com for a Return Authorization Number (RMA). After receiving your RMA send it postage paid, fully insured, with a brief written description of the problem to:

FUELAB Warranty Department, 1605 Eastport Plaza Drive, Suite 125, Collinsville, IL 62234

We will inspect your Product and contact you within 72 hours of receipt to give the results of our inspection and an estimate of the labor and/or parts charges required to fix the Product, if applicable. If covered under this limited warranty Manufacturer will repair Product and return it to you at no cost. If the Product is NOT covered under this warranty and if you authorize repairs, we will return the repaired Product to you COD, or prepaid via credit card, within 72 hours. There is no charge for inspection. If return product is found to be free of defects a \$25.00 shipping and handling charge will be applied. We will return the repaired Product to you COD, or prepaid via credit card, within 72 hours.