

Operating and Installation Instructions

CAUTION!

This product is to be installed only by persons knowledgeable in the repair and modification of vehicle fuel systems and general vehicle systems modification. Only a qualified technician or mechanic who is aware of applicable safety procedures and fabrication skills should perform the installation of this product.

GASOLINE AND OTHER FUELS ARE FLAMMABLE AND CAN BE EXPLOSIVE!

Perform the installation in a well ventilated location only to minimize the build up of fuel vapors. **NO** open flames, smoking or other sources of ignition are to be present during installation, to prevent fire or explosion that can cause serious injury or death. Grinding, cutting, and drilling must be performed with care to prevent ignition. Draining and removal of all fuel and ventilation of vapors in vehicle and fuel system is recommended when performing such procedures. Proper eye and personal protection is required at all times during installation.

WARNING!

The Vehicle's fuel system may be under pressure! Do not loosen any fuel connections until relieving all fuel system pressure. Consult an applicable service manual for instructions to relieve fuel system pressure safely.

This product is intended for racing, off-road, or marine use only. This fuel system component may not be legal for sale or use on emission controlled motor vehicles; consult local, state and national laws.

This Fuel Surge Tank System is compatible only with Pump or Racing Gasolines, E85 or all Ethanol blends. This Fuel Surge Tank is **NOT** compatible or covered under warranty with use of Diesel or Methanol Fuels

Product Contents:

Check the diagram and list of components (right) to ensure that no components are missing from box. Contact your Fuelab distributor immediately for replacement.

60711 Features and Performance Ratings:

Inlet / Return Port Sizes	3x -8AN
Outlet Port Size	-8AN
Rated Flow Rate	90 GPH @ 45 PSI, 13.8V (340 LPH @ 3 Bar)
Maximum Pressure	85 PSI (5.9 Bar)
Operating Voltage	8-18 Volts

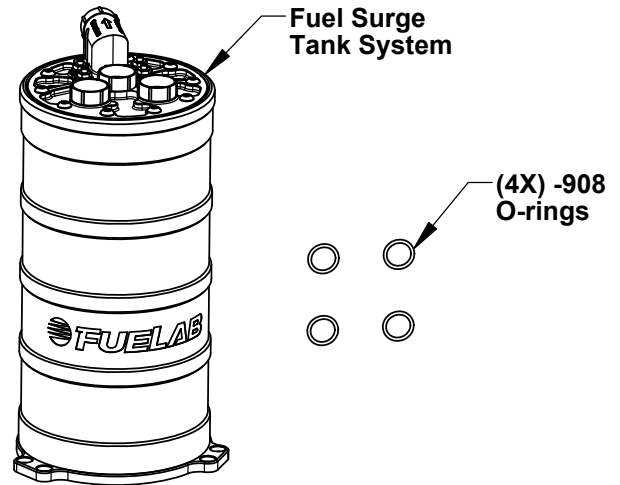

WARNING! This fuel surge tank system has a high capacity flow output, and also consumes a larger than normal electrical current draw. The vehicle's fuel pump wiring may be insufficient to power this fuel surge tank system safely as well as voltage drops through its use will dramatically affect flow output. Use of an aftermarket, high current relay electrical system is highly recommended.

Before Installation, Plan Entire Fuel System:

A complete design plan of the entire fuel system must be created for the specific application. These instructions are a guide to help design this plan with respects to integrating this model of fuel surge tank system only. Consult other sources of information and manufacturers instructions for the various components of the fuel system. These instructions are limited to general topics of fuel surge tank system installation and may not include specific information pertaining to your specific application. This fuel surge tank system may be integrated in some general carbureted systems using a bypass system. Visit our company website (www.fuelab.com) for specific details pertaining to example fuel systems and other solution ideas. Additional information including advanced troubleshooting, any special alerts and FAQ's pertaining to this and other products is also available. A good design plan for the fuel system must contain consideration for: Pressure and flow rate through various components, quality of components, operating environment (temperature, vibration, shock, general exposure to elements) and local area laws. Begin installation of Fuel Surge Tank only after a complete plan is established to help avoid fuel system component failure, costly rework, and excessive installation time.

Plumbing Planning Notes:

Mount FST System in a near-vertical position to ensure proper performance. Adequate structural mounting and support is the responsibility of the fabricator or installer using high strength #12 or M6 Hardware at the base or supplemental mount via band clamp along top flange only (**NOT** along tube of FST). Mount the FST System away from sources of heat or in an areas prone to collision damage without it being vulnerable to road hazards or debris.

CRITICAL NOTE: Fuel Surge Tank itself can only be pressurized to **15 PSI MAXIMUM!** An unrestricted return line from Fuel Surge Tank to the main vented fuel tank or fuel cell **MUST BE USED!** Use of a -8AN (1/2") or larger return line is recommended to help prevent pump cavitation or fuel starvation during high engine demand or main fuel tank sloshing conditions.

Typically -8AN (1/2") to -10AN (5/8") line size is required for the rest of the fuel system. All fuel line used must handle high pressure and be compatible with the fuel intended for use. The use of fuel line such as stainless steel braided line and "AN" style fitting connections is recommended. The fuel ports (one -8AN Outlet Port and three -8AN Inlet / Return Ports) use "AN" or "military" style fittings. This plumbing standard is commonly used with racing and high performance applications. See step 4 on next page for additional information on this port standard. A fuel filter with a 60 micron or lower particle rating is required to be used upstream of regulator and downstream from the Fuel Surge Tank System to protect it and the fuel injectors from foreign object damage. Reference the Schematic Diagram below for filter location. Use of a liquid filled gauge exposed to engine compartment heat is not recommended as the liquid inside the gauge may exert measurement errors, all mechanical gauges and pressure transducers have amounts of error due to temperature fluctuation, be aware of inaccurate pressure readings. **DO NOT** plumb gauge port to any gauge mounted inside the vehicle or in passenger compartment. A line burst can spill fuel inside passenger compartment and on occupants, possibly causing serious injury or death. An electronic gauge or pressure transducer system is recommended for readings in a passenger compartment.

Typical EFI V-8 Fuel System Plumbing Schematic Diagram:

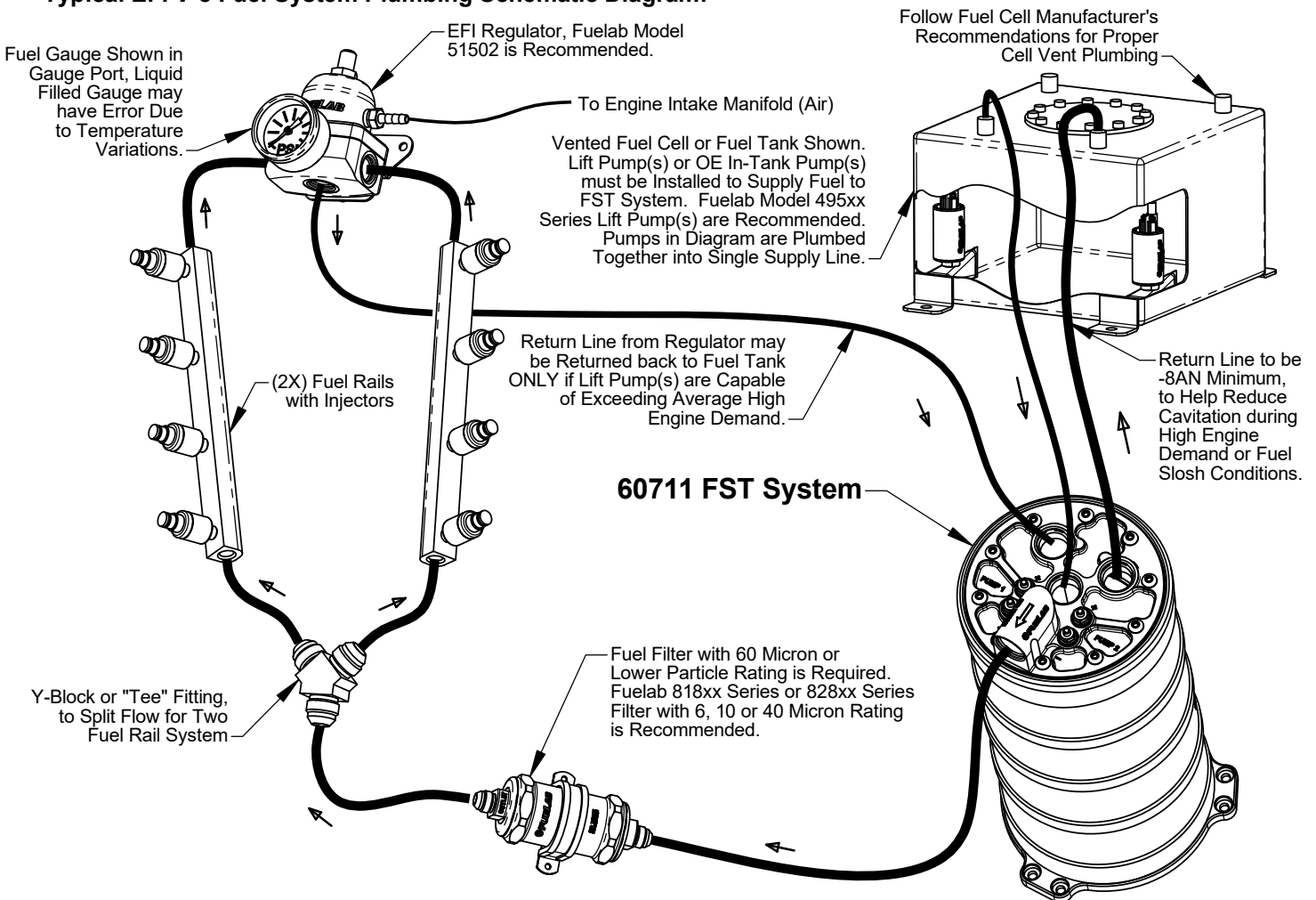

Special Note: Use in carbureted systems require a bypass return or relief valve.
Do not "Dead Head" Fuel Surge Tank System.

Electrical Planning Notes:

Reference below, for schematic wiring diagram example. Use electrical components as described including electrical connectors that are appropriate for the operating environment of the fuel system, whether its use in street, racing, or marine applications. Electrical connectors for the power leads must be capable of high current draw, note all connections, wire and component rating requirements herein. Solder and use shrink wrap for wire splices for extra reliability. Main wiring schematic diagram below shows the control of relay by ignition switch. This source can be changed as described, or by a toggle switch. Some forms of racing have specific rules regarding electrical switching of fuel system. Consult appropriate racing guidelines, rules and regulations.

MAIN WIRING SCHEMATIC DIAGRAM: (Electrical components shown are not supplied with FST System)

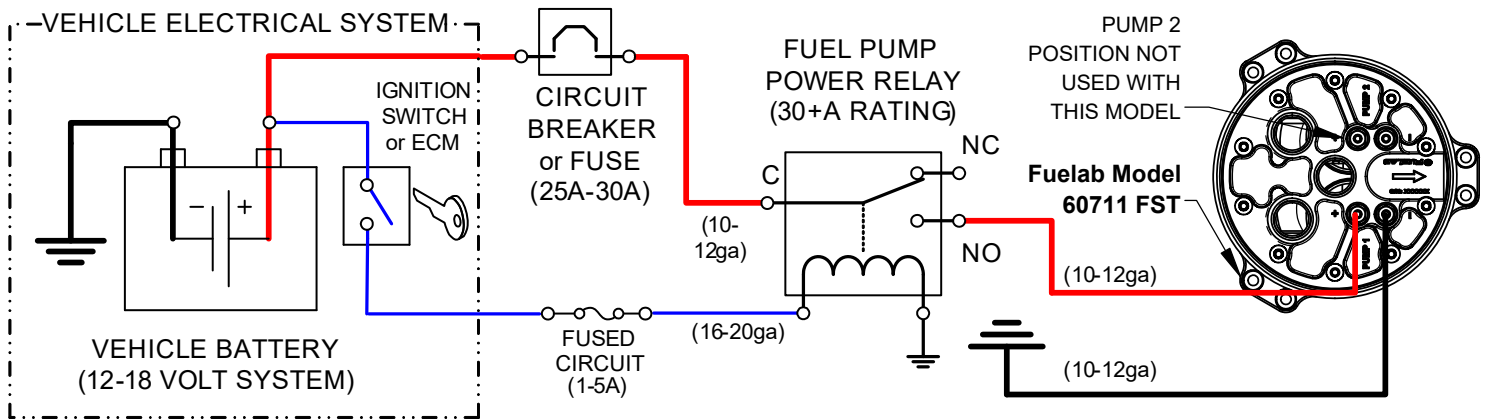

Installation Steps:

1. Disconnect the ground terminal from battery and allow the vehicle's engine and exhaust system to cool. Relieve fuel system pressure per applicable service manual. Follow all Warnings, Cautions and Instructions written on previous pages of these instructions.
2. Modify, remove or replace other fuel system components as required per established build plan (reference notes on previous pages and above).
3. Use the base of the Fuel Surge Tank as a drilling template to mark holes for mounting. Choose a location that minimizes exposure to road hazards and debris, away from engine exhaust pipes. Note position and plumbing requirements as stated earlier in these instructions.
4. Install the fuel fittings (not supplied). The threads used on these Fuel Ports are not tapered or pipe threads. Do not use Teflon[®] thread tape or thread sealant on these threads, as this can cause leakage or introduce debris into the fuel system. Fittings to be used with these style of ports require use of the enclosed -908 O-rings for proper sealing. Use light oil to lubricate the O-rings just prior to installation. Install the O-rings onto the fuel fitting first. Position the O-ring in the thread relief of the fitting. Thread fitting into regulator and tighten between 5 and 15 ft-lbs of torque.
5. Inspect fuel system for any contact of fuel lines or wires with other components that can cause chafing or rubbing. Secure all components and fuel lines. Ensure that moving components of vehicle are clear.
6. Connect the vehicle's battery. Perform initial priming: The Fuel Surge Tank System may require priming during initial operation. This action can be accomplished by removing fuel line from fuel rail (downstream of Fuel Surge Tank and filter), allowing the fuel line to empty fluid into fuel safe container. Operate fuel system until fuel exits fuel line. Attach fuel line back to the fuel rail after priming fuel system. After tightening connection, verify leak-free operation while checking fuel rail pressure. If fuel pressure is not high enough, repeat priming procedure to ensure that Fuel Surge Tank is receiving fuel from tank. Turn on fuel system (typically by bypassing fuel pump relay) without engine operating. ECU or engine management computer may be controlling the relay. The ECU may only operate fuel system for a few seconds each time ignition switch is set to on. The fuel system will have to operate several seconds (30+) to prime and drive air out of the fuel system. Reattach fuel rail line. Start fuel system and inspect for leaks. Fuel system pressure should read about the set pressure (use an external gauge for adjustment if a permanent gauge is not used). Inspect vehicle for any leaks. Turn off fuel system and repair any leaks that may be present before continuing.
7. When adjusting pressure, be sure that fuel system is operating to monitor pressure. Fuelab recommends to use a "baseline" pressure reference when adjusting the pressure (adjusting the pressure with engine off or Pressure Reference Line unhooked). The vehicle's engine may not produce consistent vacuum during idle to have repeatable readings.
8. After final adjustment of fuel pressure, tighten Jam Nut. Road test vehicle, and retest pressure upon return to ensure accurate adjustment. After installation of this Fuel Surge Tank, verify flow capacity to ensure safe levels of flow. Having insufficient flow capacity can result in an engine lean-out condition that can cause severe engine damage. Collecting a given amount of fuel (as measured by weight or volume) over a measured

amount of time can be used to determine capacity. Collect fuel flow from the return line to measure the amount of fuel capacity at a given operating pressure. A 20+ ampere capacity battery charger may be used to simulate the charging system of the vehicle while engine is off. If using an adjustable fuel pressure regulator, for boosted applications, simulate boost by raising the fuel pressure by the amount of expected maximum boost pressure. Performing these tests will give greater accuracy for capacity tests.

Fuel System Maintenance Notes:

Periodic inspection and general maintenance is required for longevity and reliability of the fuel system. This action directly affects the fuel pump's performance and reliability. Included with that are periodic inspection and/or filter element replacement. Straining Filters (upstream of Fuel Surge Tank as well as internal straining filters) should be checked and cleaned at least every 50,000 miles (more often for off-road operating conditions). Replace or clean downstream filters (after Fuel Surge Tank) every year or 15,000 miles (more often for off-road operating conditions). Dirty fuel filters can block flow and adversely affect fuel system performance as well as can directly damage the Fuel Surge Tank System.

Special alert for E85 or Methanol Users: **DO NOT** use cellulose (paper) based filter elements! Water can contaminate the fuel and break down the element, creating debris that can damage injectors and Fuel Surge Tank.

Troubleshooting Notes:

Problem (Symptom)	Possible Causes	Possible Solutions
Not operating.	<ul style="list-style-type: none"> • Faulty fuel pump relay. • Faulty, dirty or corroded electrical connections or improperly sized wire. 	Check voltage to Fuel Surge Tank, at power terminals. If voltage is steady and consistent (within 1/2 Volt of battery) then contact Fuelab for assistance or repair. If voltage is inconsistent as described, repair or replace electrical components as required.
Not building up fuel pressure.	<ul style="list-style-type: none"> • Incorrect fuel system initial priming procedure. • Improperly mounted Fuel Surge Tank or low fuel level. 	Repeat procedure for proper priming, check fuel level as well as Fuel Surge Tank voltage.
Loss of fuel pressure or erratic pressure pulsation after several minutes of operation.	<ul style="list-style-type: none"> • Cavitation (vapor lock) due to overheating or restricted inlet. 	Check temperature of return line right after failure. If return line is hot to touch (uncomfortable to leave hand on Fuel Surge Tank due to it being too hot, or above 120°F), then look for sources of heat such as exhaust or fuel rail mountings that could be conducting too much heat. If return line is not hot to the touch, check for inlet restrictions such as improperly vented tank or inspect module and straining filter in lift pump. Contact Fuelab, as Fuel Surge Tank may be damaged due to improper operating condition for repair or consultation.

Please do not return this product to your retailer. If you experience any performance, reliability or problems during installation or use of this product, please contact Fuelab immediately!

For more tips, advise or troubleshooting please visit our website at www.fuelab.com, e-mail message to info@fuelab.com or call our tech department at 618-344-3300 between 8am and 5pm Central Standard Time.

LIMITED WARRANTY

FUELAB, a division of FCP, Inc., having its principal place of business at **1605 Eastport Plaza Drive, Suite 125, Collinsville, IL 62234, USA** ("Manufacturer") warrants its **FUELAB** products (the "Products") as follows:

1. Limited Warranty.

Manufacturer warrants that the Products sold hereunder will be free from defects in material and workmanship for a period of 2 Years from the date of purchase to the original purchaser. If the Products do not conform to this Limited Warranty during the warranty period (as herein above specified), Buyer shall notify Manufacturer in writing, or by phone, of the claimed defects and demonstrate to Manufacturer satisfaction that said defects are covered by this Limited Warranty. If the defects are properly reported to Manufacturer within the warranty period, and the defects are of such type and nature as to be covered by this warranty, Manufacturer shall, at its own expense, furnish replacement Products or, at Manufacturer's option, replacement parts for the defective Products. Removal of Products from vehicle (*Vehicle means any automotive, bike or marine transportation powered by an internal combustion engine. This product is **NOT** intended or designed for use on aircraft, experimental or otherwise.*), shipping to Manufacturer and installation of the replacement Products or replacement parts shall be at Buyer's expense.

2. Other Limits.

THE FOREGOING IS IN LIEU OF ALL OTHER WARRANTIES, EXPRESS OR IMPLIED, INCLUDING BUT NOT LIMITED TO THE IMPLIED WARRANTIES OF MERCHANTABILITY AND FITNESS FOR A PARTICULAR PURPOSE. Manufacturer does not warrant against damages or defects arising out of improper or abnormal use or handling of the Products; against defects or damages arising from improper installation (where installation is by persons other than Manufacturer), against defects in products or components not manufactured by Manufacturer, or against damages resulting from such non-Manufacturer made products or components. Manufacturer passes on to Buyer the warranty it received (if any) from the maker thereof of such non-Manufacturer made products or components. This warranty also does not apply to Products upon which repairs have been effected or attempted by persons other than pursuant to written authorization by Manufacturer.

3. Exclusive Obligation.

THIS WARRANTY IS EXCLUSIVE. The sole and exclusive obligation of Manufacturer shall be to repair or replace the defective Products in the manner and for the period provided above. Manufacturer shall not have any other obligation with respect to the Products or any part thereof, whether based on contract, tort, strict liability or otherwise. Under no circumstances, whether based on this Limited Warranty or otherwise, shall Manufacturer be liable for incidental, special, or consequential damages.

4. Other Statements.

Manufacturer's employees, representatives' and/or resellers ORAL OR OTHER WRITTEN STATEMENTS DO NOT CONSTITUTE WARRANTIES, shall not be relied upon by Buyer, and are not a part of the contract for sale or this limited warranty.

5. Entire Obligation.

This Limited Warranty states the entire obligation of Manufacturer with respect to the Products. If any part of this Limited Warranty is determined to be void or illegal, the remainder shall remain in full force and effect.

6. Warranty Service

What Does This Warranty Not Cover? Any problem that is caused by abuse, misuse, or an act of God (such as a flood) is not covered. Also, consequential and incidental damages are not recoverable under this warranty. Some states do not allow the exclusion or limitation of incidental or consequential damages, so the above limitation or exclusion may not apply to you.

How Do You Get Service? In order to be eligible for service under this warranty you **MUST** return the Warranty Registration card, or register on-line at www.fuelab.com/warranty-registration within 30 days of purchasing the Product.

If something goes wrong with your product contact FUELAB at 618-344-3300, or send an e-mail to: info@fuelab.com for a Return Authorization Number (RMA). After receiving your RMA send it postage paid, fully insured, with a brief written description of the problem to:

FUELAB Warranty Department, 1605 Eastport Plaza Drive, Suite 125, Collinsville, IL 62234

We will inspect your Product and contact you within 72 hours of receipt to give the results of our inspection and an estimate of the labor and/or parts charges required to fix the Product, if applicable. If covered under this limited warranty Manufacturer will repair Product and return it to you at no cost. If the Product is NOT covered under this warranty and if you authorize repairs, we will return the repaired Product to you COD, or prepaid via credit card, within 72 hours. There is no charge for inspection. If return product is found to be free of defects a \$25.00 shipping and handling charge will be applied. We will return the repaired Product to you COD, or prepaid via credit card, within 72 hours.



www.fuelab.com

1605 Eastport Plaza Drive, Suite 125, Collinsville, IL 62234
618-344-3300